

# 260 mm Cavity Brick Sections

OUTWARD OPENING  
AWNING OR CASEMENT WINDOW

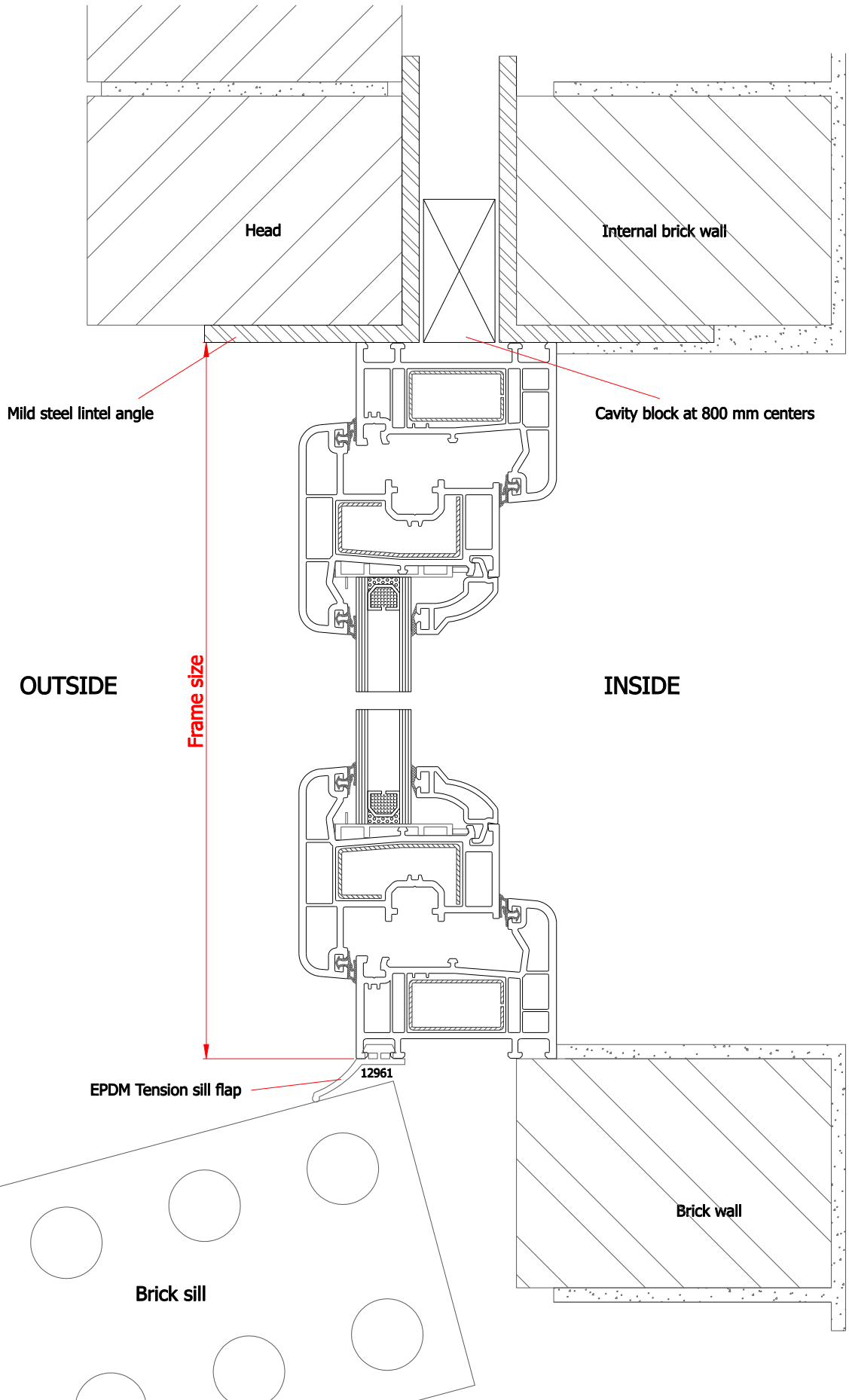
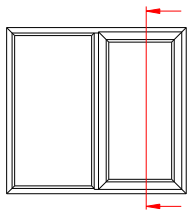

# 260 mm Cavity Brick Sections

OUTWARD OPENING  
AWNING OR CASEMENT WINDOW

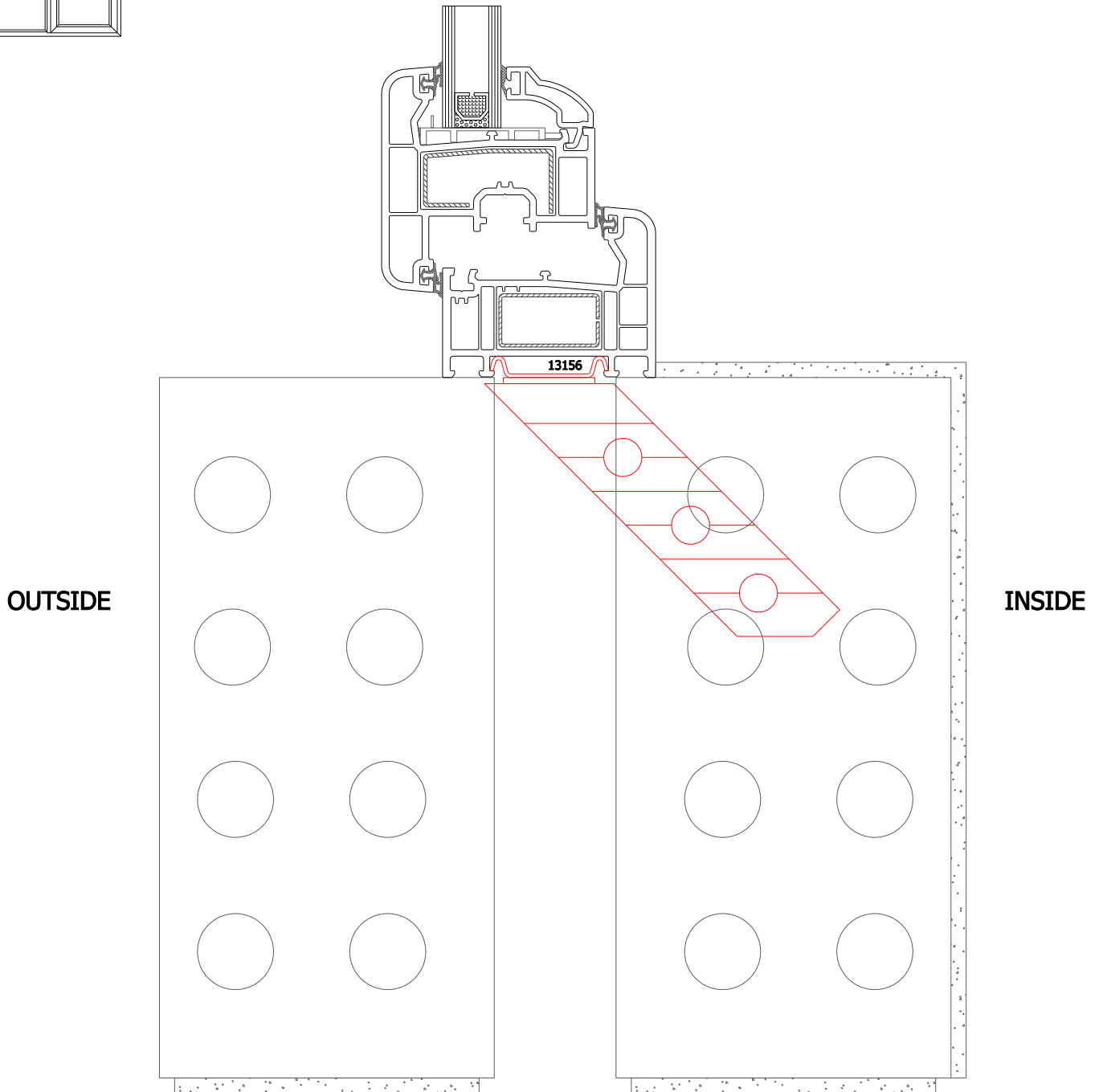
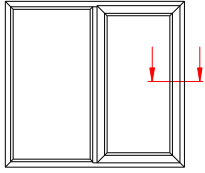

# 250 mm Brick Veneer Sections

OUTWARD OPENING  
AWNING OR CASEMENT WINDOW

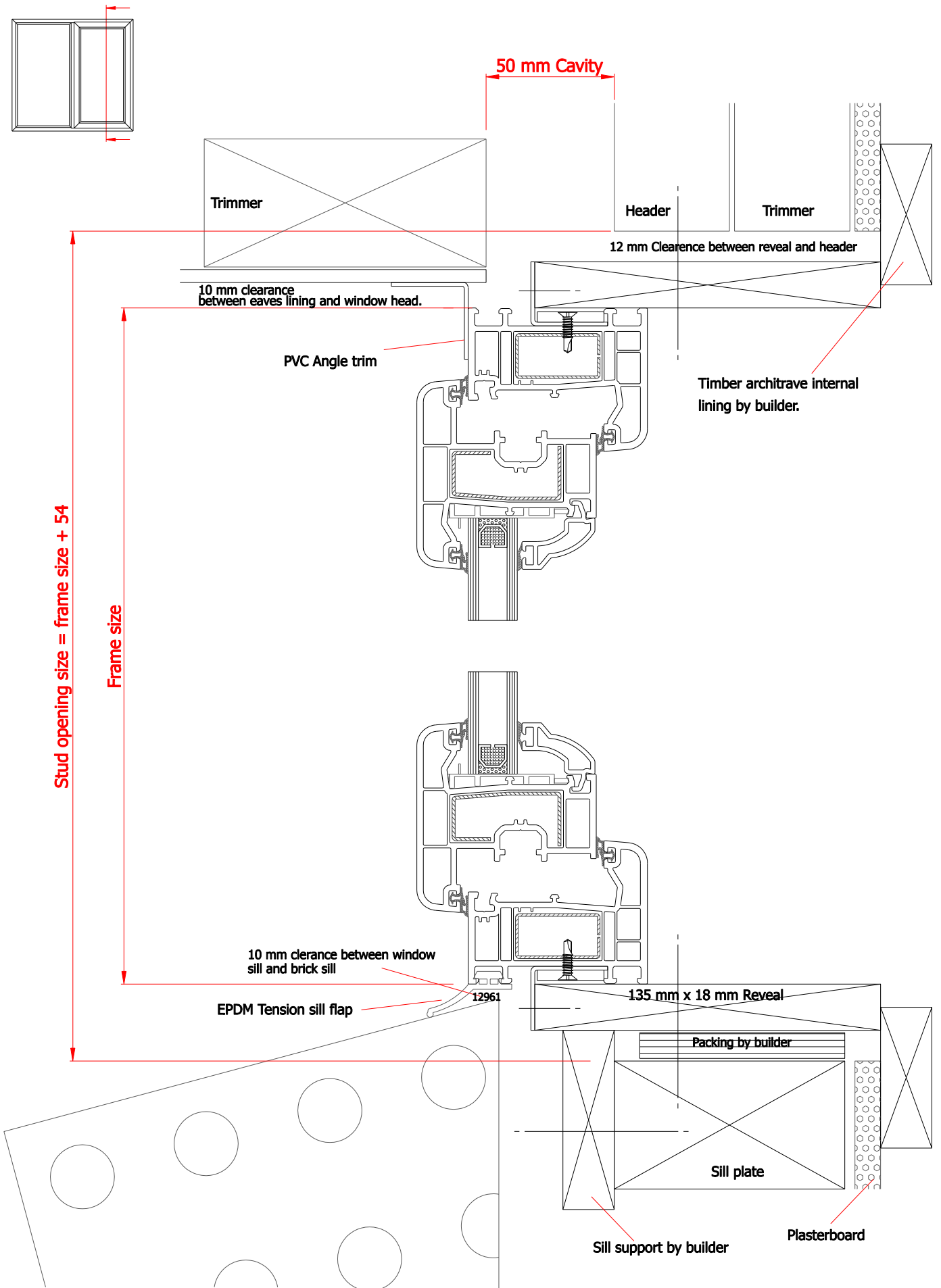

# 250 mm Brick Veneer Sections

OUTWARD OPENING  
AWNING OR CASEMENT WINDOW

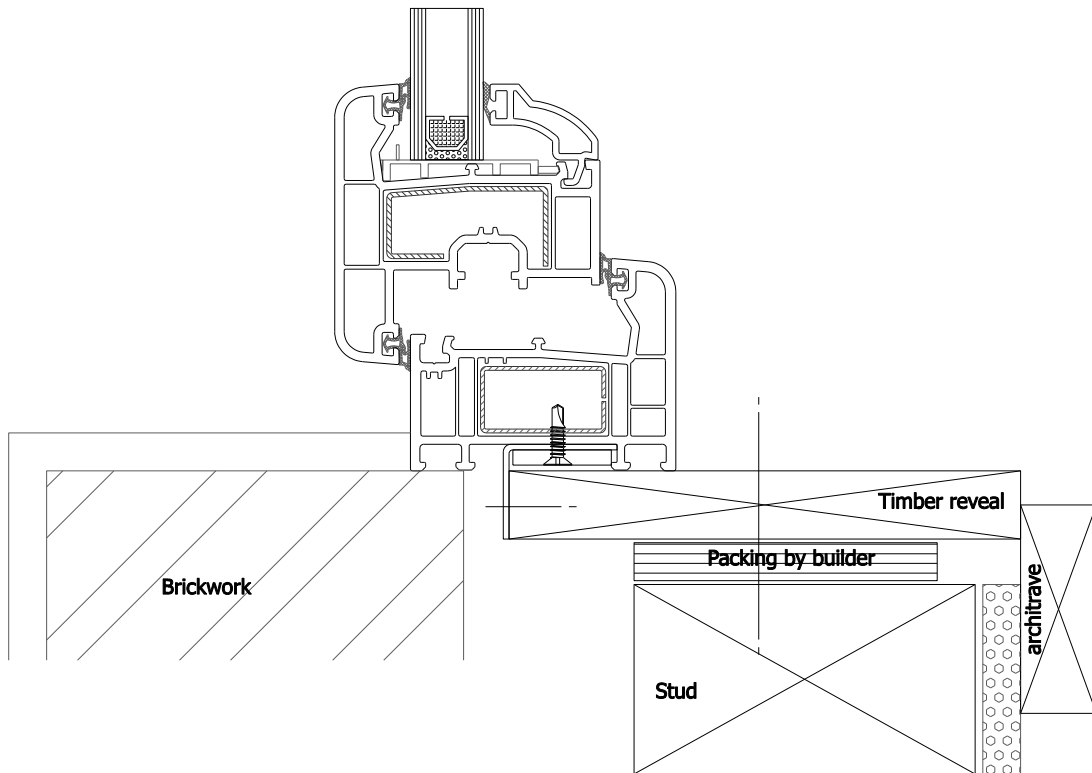
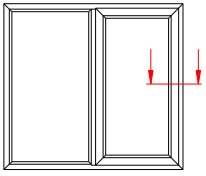

# 250 mm Brick Veneer Sections

OUTWARD OPENING  
AWNING OR CASEMENT WINDOW

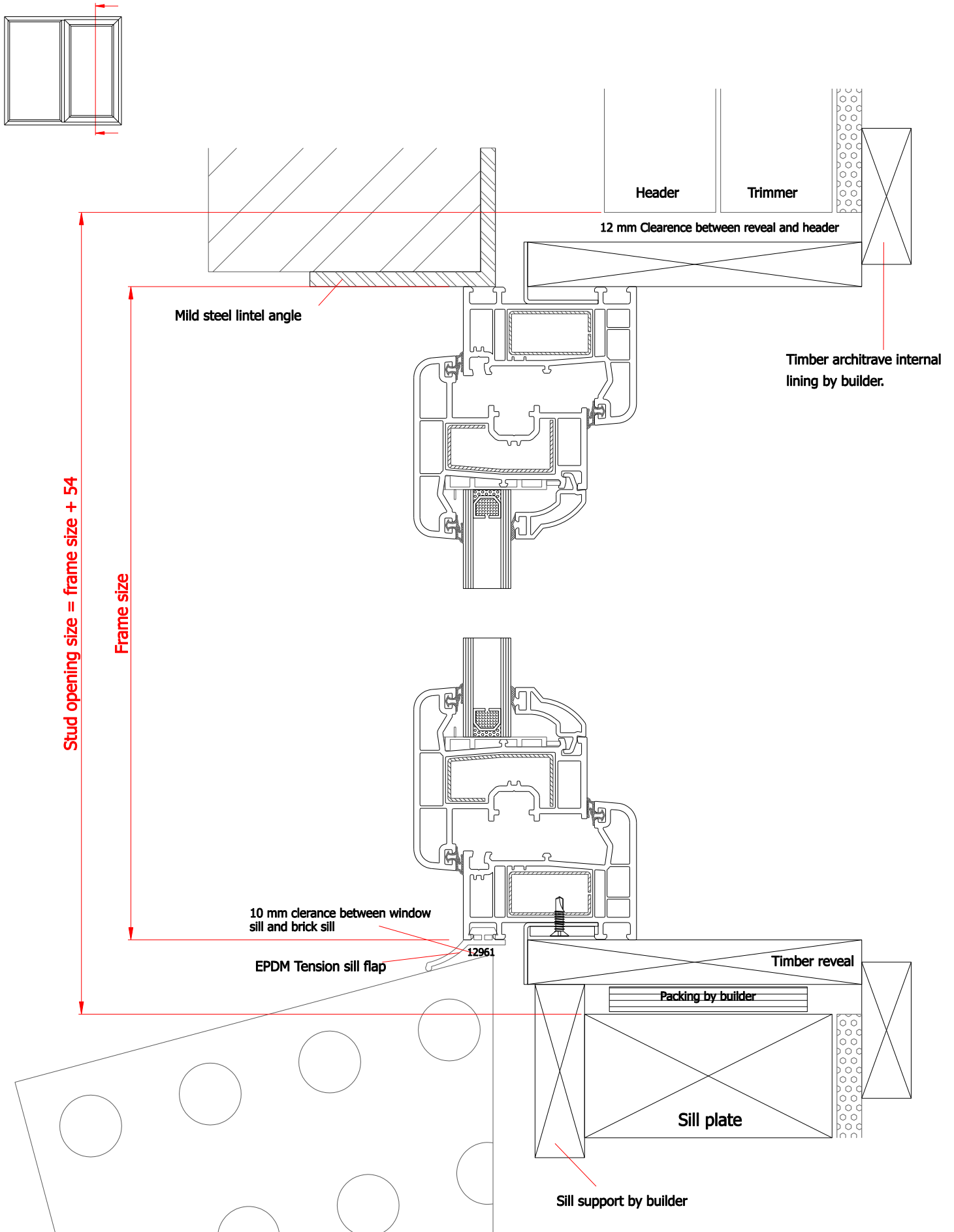

# 115 mm Single Skin Brick

OUTWARD OPENING  
AWNING OR CASEMENT WINDOW

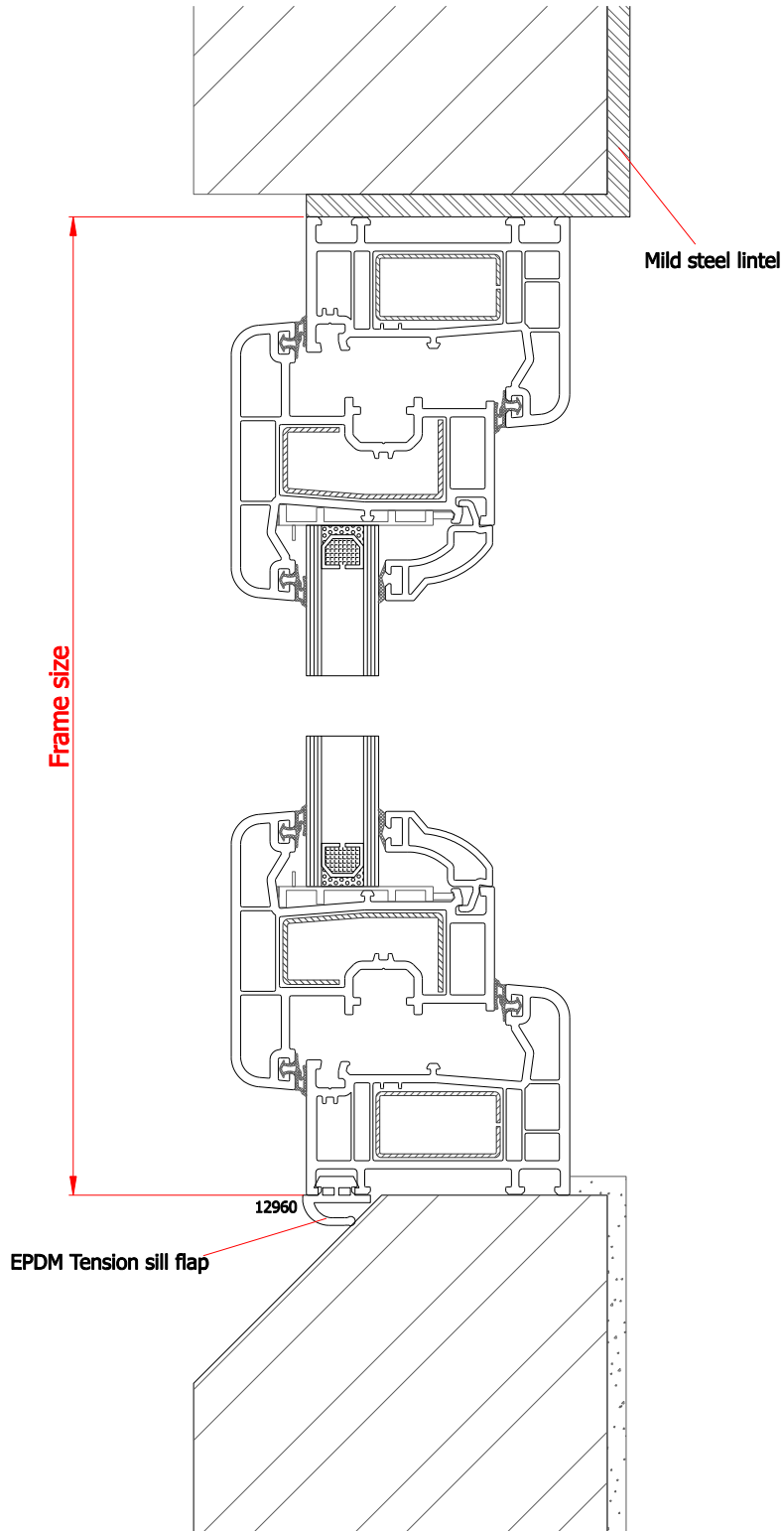
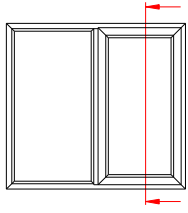

# Block Wall Construction

OUTWARD OPENING  
AWNING OR CASEMENT WINDOW

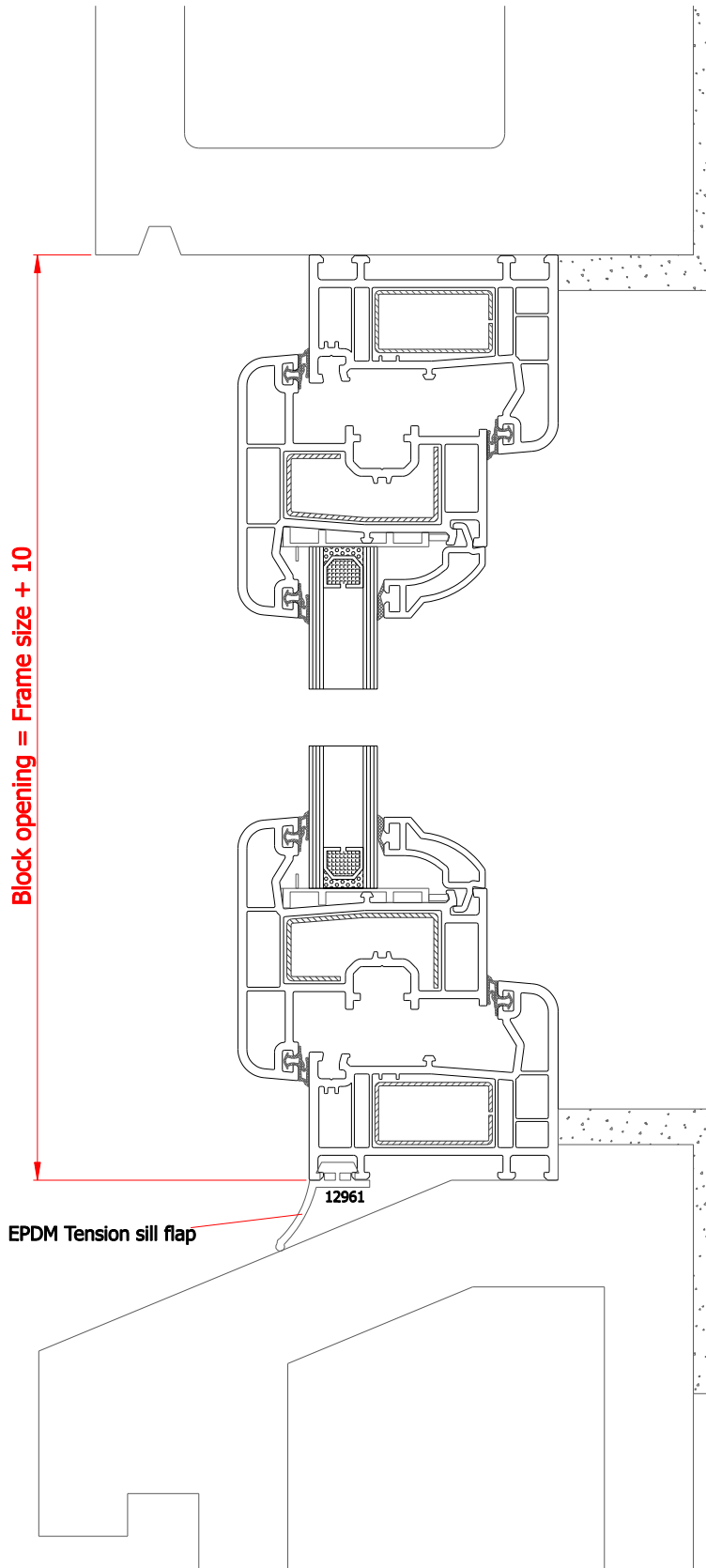
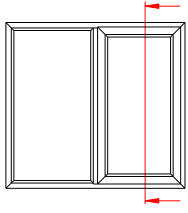

# Block Wall Construction

OUTWARD OPENING  
AWNING OR CASEMENT WINDOW

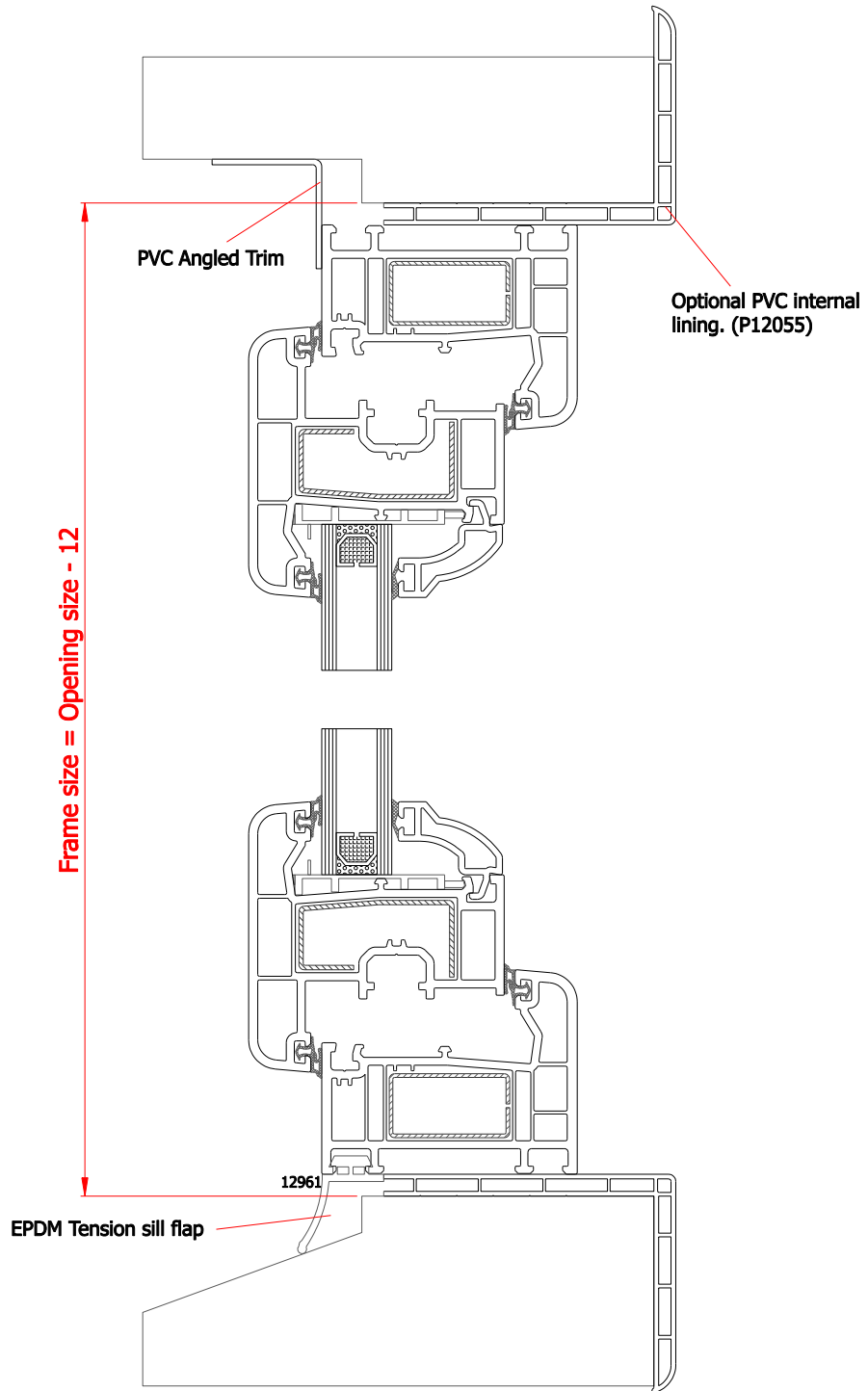
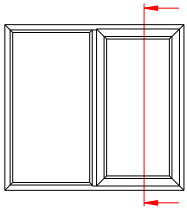



OUTWARD OPENING  
AWNING OR CASEMENT WINDOW

